



**SAH**  
Stahlwerk Annahütte

# SAS post-tensioning system

## Manual

**SAS SYSTEMS**



MAX AICHER

# Contents

<b>SAS Post Tensioning System</b> .....	3
Introduction .....	3
Function of PT systems .....	3
SAS PT bars.....	4
Accessories and Approval for SAS 950/1050.....	5
SAH quality assurance.....	9
<b>Recommendations for the dimensioning of the SAS PT system</b> .....	9
Recommendations for the maximum prestressing forces of the SAS post-tensioning bar tendon system.....	9
Slip values and stressing of the SAS PT system.....	10
Stress control / lift-off-test .....	11
<b>Installation and corrosion protection system</b> .....	12
General.....	12
Available PT systems and corrosion protection.....	12
Corrosion protection of bonded SAS bar tendons .....	13
Corrosions protection of unbonded SAS bar tendons .....	13
Corrosion protection with heat-shrinking sleeve and PE tube.....	13
Corrosion protection by means of factory pre-filling with corrosion protection compound or cement grout .....	14
Installation basics.....	14
Prestressing of SAS PT bars .....	15
<b>Handling instructions</b> .....	16
Transport and storage .....	16
Protection against corrosion damage on the construction site.....	17
Protection of the prestressing bars against damage .....	17
Heat protection.....	17
Installation/handling.....	18
<b>Design guide SAS 950/1050</b> .....	18
<b>Design guide SAS 835/1035</b> .....	18
Prestressing bar system – Mechanical and technological characteristics .....	19
Prestressing bar system – Design forces .....	20
Mechanical anchorage WITHOUT additional bursting reinforcement .....	20
Mechanical anchorage WITH additional bursting reinforcement.....	20
Post-tensioned systems.....	21
Rock and soil anchors .....	24
Accessories – (double) corrosion protection for rock and soil anchors.....	26

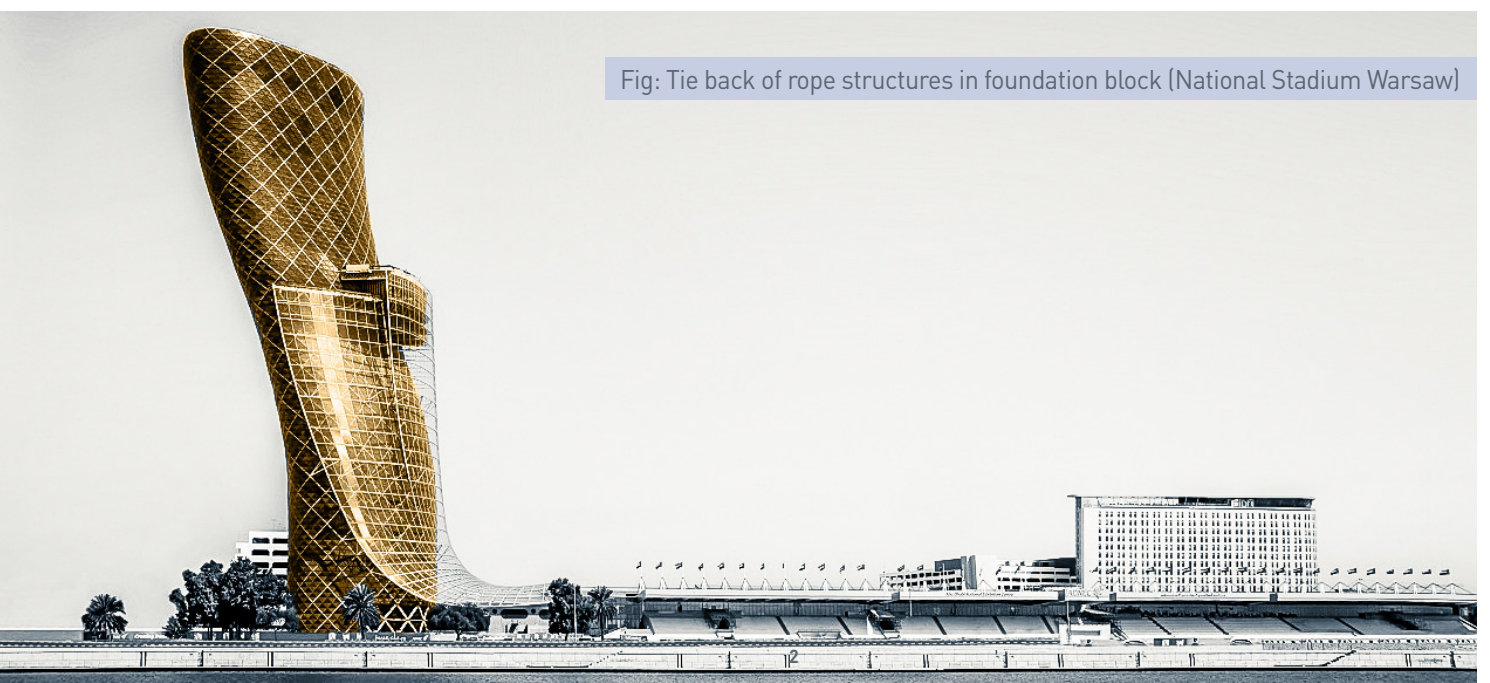

Fig: Tie back of rope structures in foundation block (National Stadium Warsaw)

## Introduction

Over the past years, the SAS post-tensioning bar tendon system using SAH SAS 950/1050 thread bars has been successfully used in numerous projects to tie back steel structures. Due to its importance for the load-bearing behaviour of the entire structure, planning and installation must be carried out very carefully.

Stahlwerk Annahütte holds the European technical approval ETA-05/0122 for the SAS post-tensioning bar tendon system which specifies all system-relevant technical data for the designer. In case of questions regarding the approval, please contact SAH. The provisions of the currently valid approval are binding and must be observed.

## Function of post-tensioning systems

Concrete lacks 'tensile' strength. That's why steel reinforcing bars – 'rebar' – are often embedded in the concrete to absorb tensile forces and limit the width of cracks respectively ensure the durability. However, rebar provides only passive reinforcement – that is, it does not bear any load or force until the concrete has already cracked.

This is where post-tensioning comes in. PT systems provide active reinforcement. The function of post-tensioning is to place the concrete structure under compression in those regions where load causes tensile stress. Post-tensioning applies a compressive stress on the material, which offsets the tensile stress the concrete might face under loading. PT systems lead collectively not necessarily to an increased load capacity of a system, however, serve to enable the serviceability of components.

SAS post-tensioning bars are an integral part of modern post-tensioning solutions in bridge construction, structural engineering and the retrofitting of structures. SAS post-tensioning bar systems comprise post-tensioning thread bars and smooth bars of the grade SAS 950/1050 or SAS 835/1035, as

Pre-assembly of the tendons, installation and tensioning must be carried out by a PT company approved by SAH (specialist company according to CWA 14646).

It is recommended that SAH-approved PT companies or SAH be contacted early on in the designing stage in order to clarify important aspects of the detailing and installation sequence.

This document provides general design recommendations which, in addition to the provisions specified in the ETA-05/0122 or other relevant standards, offer to the designer specific information on the use of tiebacks in steel structures. Other applications require the approval of SAH or a SAH-approved PT company.

well as tested and approved anchorage elements and couplings. SAS post-tensioning bar systems have been successfully used for many years for transversely post-tensioning bridges and pylon heads. They have also been used worldwide in hall and stadium construction projects to tie back steel structures and rope systems and as auxiliary construction tools in bridge construction for attaching launching noses and form travellers.

To improve and ensure a functioning infrastructure that meets the needs of a growing economy and population, existing structures will have to be upgraded in the years to come. SAS post-tensioning bar tendons have already been successfully employed for strengthening existing bridges, thus providing eco-efficient, long-lasting and future-oriented solutions.

Modern wind power plants require simple, quick and cost-efficient construction systems. SAS post-tensioning bar tendons installed in the base and shaft help optimize the construction progress, thus promoting the move towards renewable energy resources. The European Technical Approval ETA-05/0122 offers designers a tested system that takes all project-specific conditions into account, e.g. post-tensioning anchors, load transfer to concrete and corrosion protection.

# SAS Post-tensioning System

## SAS PT bars

SAS post-tensioning bars are hot rolled, heat treated, stretched and tempered grade Y1050 or Y1035 bars Grade SAS 950/1050 even meets the prEN10138-4.

Due to the manufacturing process, SAS 950/1050 and SAS 835/1035 steel bars, as compared to standard steel bars, fea-

ture a distinct and well defined yield point while at the same time possessing high strength and ductility.

SAS prestressing steels are available as thread bars with hot-rolled coarse threads or smooth bars with cold-rolled special threads in mill lengths of up to 18m.

WR bars

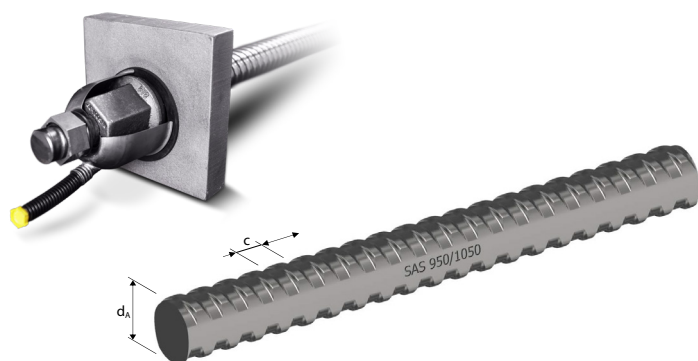

SAS 950/1050 Ø 18 - 26.5 - 32 - 36 - 40 - 47  
SAS 835/1035 Ø 57 - 65 - 75

WS bars



SAS 950/1050 Ø 26.5 - 32 - 36 - 40

SAS post-tensioning thread bars feature a rolled-on continuous right hand coarse thread. Thus WR bars can be cut at any point along their length or extended by couplers. Thanks to the special WR thread, SAS post-tensioning thread bars are screwable even under very rough construction site conditions.

SAS smooth post-tensioning bars feature a round cross-sectional shape. The special thread is rolled on at the factory according to customer or project specific requirements. The smaller pitch of their special thread make SAS smooth post-tensioning bars ideally suited for short tendons of up to 3m in length.

Over the last 30+ years, the SAS post-tensioning bar tendon system has been successfully used in numerous projects – as the ETA-approved system SAS 950/1050 Ø18-47 as well as the system SAS 835/1035 Ø57-75 for special applications. SAS PT-bars are hot-rolled, stressed and stress relieved. Due to this

manufacturing process SAS PT-bars fulfill the requirement in the American standard ASTM 722. Further the stressing process of all bars for receiving the special properties can be considered as a 100% proof test of every individual bar.

Available bar diameters and load capacities are shown in the following table.

Diameter Ø [mm]	Yield load $F_{p0.1k}$ [kN]	Ultimate load $F_{pk}$ [kN]	Cross section area A [mm <sup>2</sup> ]	Weight G [kg/m]	Elongation $A_{gt}$
<b>SAS 950/1050</b>					
18	230	255	241	1.96	5%
26.5	525	580	551	4.48	
32	760	845	804	6.53	
36	960	1070	1020	8.27	
40	1190	1320	1257	10.21	
47	1650	1820	1735	14.10	
<b>SAS 835/1035</b>					
57	2155	2671	2581	20.95	4%
65	2780	3447	3331	27.10	
75	3690	4572	4418	35.90	

## Loads of SAS PT bars

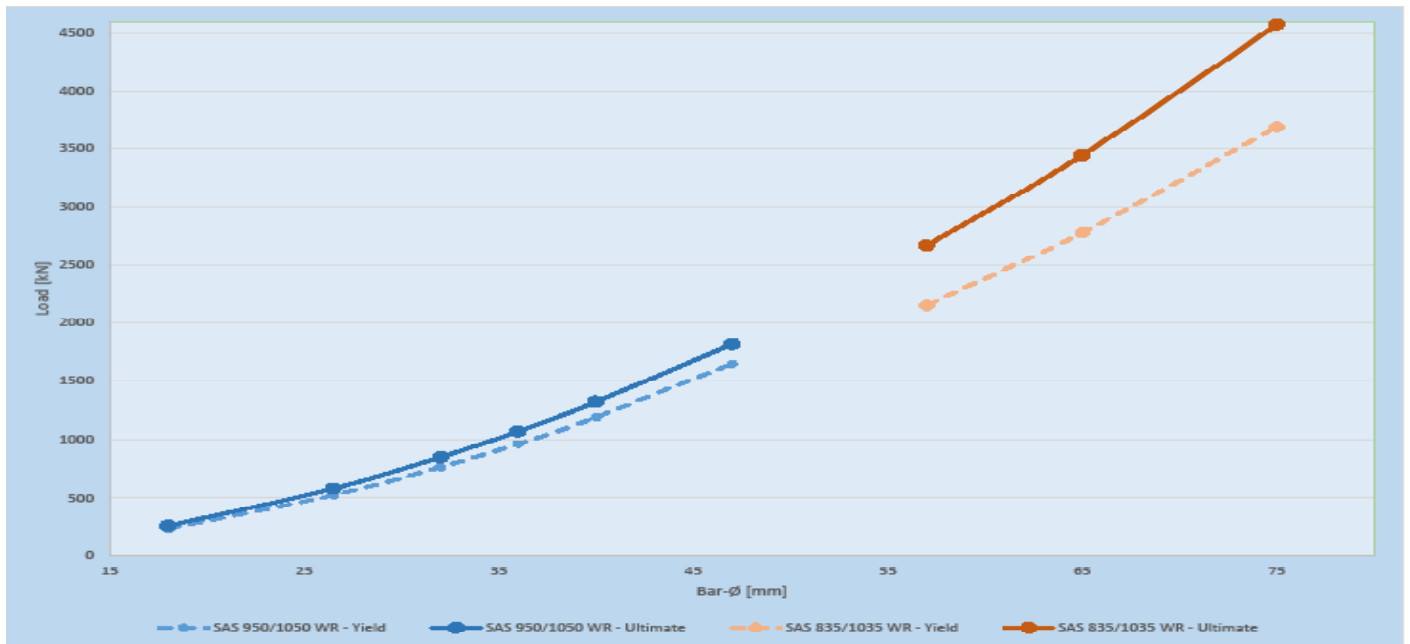

## Accessories and Approval for SAS 950/1050

All accessories are designed for full load capacity. For grade SAS 950/1050 (WR: Ø18-47, WS: Ø32-36) SAH is holder of a European Technical Assessment. This means that all parts contained in the approval have been assessed according to EAD 160004 and meet the corresponding criteria.

This also means that all accessories contained therein are regularly monitored by others in accordance with the guidelines of the EAD 160004.



**OIB**  
Austrian Institute of Construction Engineering  
Schefflenstrasse 4 | T +43 1 533 65 50  
1010 Vienna | Austria | F +43 1 533 64 23  
www.oib.or.at | mail@oib.or.at





Member of  
**ETA**  
www.oib.or.at

**European Technical Assessment** **ETA-05/0122**  
of 09.12.2019

<b>General part</b>	
<b>Technical Assessment Body issuing the European Technical Assessment</b>	Osterreichisches Institut für Bautechnik (OIB) Austrian Institute of Construction Engineering
<b>Trade name of the construction product</b>	SAS – Post-tensioning bar/tendon system
<b>Product family to which the construction product belongs</b>	Bonded, unbonded, and external post-tensioning kits for prestressing of structures with bars, diameter 17.5 to 47 mm
<b>Manufacturer</b>	Stahlwerk Annahütte Max Aicher GmbH & Co. KG 83404 Alnring-Hammerau Germany
<b>Manufacturing plant</b>	Stahlwerk Annahütte Max Aicher GmbH & Co. KG 83404 Alnring-Hammerau Germany
<b>This European Technical Assessment contains</b>	70 pages including Annexes 1 to 47, which form an integral part of this assessment.
<b>This European Technical Assessment is issued in accordance with Regulation (EU) No 305/2011, on the basis of</b>	European Assessment Document (EAD) 160004-00-0301 – Post-Tensioning Kits for Prestressing of Structures.
<b>This European Technical Assessment replaces</b>	European Technical Assessment ETA-05/0122 of 27.08.2010.

This also means that all accessories contained therein are regularly monitored by others in accordance with the guidelines of the EAD 160004. The hardware to obtain the SAS PT system is shown on the next three pages:

# SAS Post-tensioning System

SAS 950/1050 WR

<p>WR2001 domed nut 55° (ETA-05/0122)</p>		<p>WR2099 domed nut 55° with grouting slots (ETA-05/0122)</p>	
<p>WR2002 hex nut</p>		<p>WR2963 bull nose nut</p>	
<p>WR3003 coupler standard (ETA-05/0122)</p>		<p>WR3303 coupler long (ETA-05/0122)</p>	
<p>WR2011 anchor plate square (ETA-05/0122)</p>		<p>WR2012 anchor plate rectangular (ETA-05/0122)</p>	
<p>WR2074 QR plate (ETA-05/0122)</p>		<p>WR2076 solid plate rectangular small (ETA-05/0122)</p>	
<p>WR2139 anchor plate rectangular</p>		<p>WR1928 domed anchor plate rectangular</p>	



# SAS Post-tensioning System

SAS 950/1050 WS

<p>WS2001 domed nut 55° (ETA-05/0122)</p>		<p>WS2099 domed nut 55° with grouting slots (ETA-05/0122)</p>	
<p>WS2002 hex nut</p>		<p>WS2963 bull nose nut</p>	
<p>WS3003 coupler standard (ETA-05/0122)</p>		<p>WS8004 transition coupler</p>	
<p>WS2011 anchor plate square (ETA-05/0122)</p>		<p>WS2012 anchor plate rectangular (ETA-05/0122)</p>	
<p>WS2074 QR plate (ETA-05/0122)</p>		<p>WS2076 solid plate rectangular small (ETA-05/0122)</p>	
<p>WS2139 anchor plate rectangular</p>		<p>WS1928 domed anchor plate rectangular</p>	

# SAS Post-tensioning System

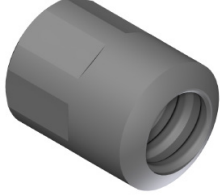
## SAS 835/1035

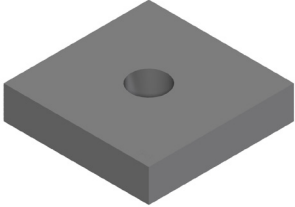
<p>WR2002 hex nut</p>		<p>WR2963 bull nose nut</p>	
<p>WR3003 coupler standard</p>		<p>WR8003 stressing coupler</p>	
<p>WR2139 anchor plate rectangular</p>		<p>WR1928 domed anchor plate rectangular</p>	

## Stressing equipment

<p>WR8002 stressing anchorage SAS 950/1050</p>		<p>WR8002 stressing anchorage SAS 835/1035</p>	
<p>WR8003 stressing coupler</p>		<p>WS8004 stressing coupler</p>	



## SAH quality assurance

The continuous improvement of our products and processes is the responsibility of all our employees. The certification of our quality management systems is proof of our deep commitment to high quality and our outstanding success in ensuring it consistently.

SAH steel is subject to annual testing and certification processes according to the German and international standard DIN EN ISO 9001, the environmental standard DIN EN ISO 14001, the energy management system DIN EN ISO 50001 and for the automotive sector, also ISO TS 16949. Our quality is „Made in Germany“.



The thread of SAS post-tensioning bars ensures that the applied prestressing force is safely absorbed by the anchor using SAS accessories adapted to suit project-specific requirements. All accessories such as anchor nuts (e.g. WR 2001, WR 2099),

couplers (WR 3003) and anchor plates (e.g. WR 2011, WR 2012, WR 2074) are continuously monitored according to the SAS quality management system.

## Recommendations for the dimensioning of the SAS PT system

### Recommendations for the maximum prestressing forces of the SAS post-tensioning bar tendon system

Pretension force during the tensioning process

Prestressing and overstressing forces are specified in the respective standards and regulations in force at the place of use. The following table lists the respective maximum values

according the European approval ETA-05/0122, Eurocode 2 and Bridge Design Specifications.

Diameter Ø [mm]	Yield load $F_{p0,1k}$ [kN]	Ultimate load $F_{pk}$ [kN]	Max. prestressing force				
			Acc. ETA-05/0122 respectively acc. EN 1992-1-1 (5.10.2)			Acc. Bridge Design Specifications (9.15.1,US)	
			$0.80 \times F_{pk}$ [kN]	$0.90 \times F_{p0,1k}$ [kN]	$0.95 \times F_{p0,1k}^*$ [kN]	$0.75 \times F_{pk}$ [kN]	$0.90 \times F_{p0,1k}^{**}$ [kN]
<b>SAS 950 / 1050 (ETA-05/0122)</b>							
18	230	255	204	-	219	191	207
26.5	525	580	464	-	499	435	473
32	760	845	676	-	722	634	684
36	960	1070	856	-	912	803	864
40	1190	1320	1056	-	1131	990	1071
47	1650	1820	1456	-	1568	1365	1485
<b>SAS 835 / 1035</b>							
57	2155	2671	-	1940	2047	2003	-
65	2780	3447	-	2502	2641	2585	-
75	3690	4572	-	3321	3506	3429	-

\* Overstressing is permitted if the force in the prestressing jack can be measured to an accuracy of +/- 5 % of the final value of the prestressing force.

\*\* For longer frame structures for short periods of time prior to seating may be permitted to offset seating losses.

# Recommendations for the dimensioning of the SAS PT system

## Pretension force after jack release

Prestressing forces after jack release are specified in the respective standards and regulations in force at the place of use. The following table lists the respective maximum values according Eurocode 2 and Bridge Design Specifications.

Diameter $\emptyset$ [mm]	Yield load $F_{p0,1k}$ [kN]	Ultimate load $F_{pk}$ [kN]	Max. prestressing force		
			Acc. ETA-05/0122 respectively acc. EN 1992-1-1 (5.10.3)		Acc. Bridge Design Specifications (9.15.1)
			$0.75 \times F_{pk}$ [kN]	$0.85 \times F_{p0,1k}$ [kN]	$0.80 \times F_{p0,1k}$ [kN]
<b>SAS 950/1050 (ETA-05/0122)</b>					
18	230	255	191	-	184
26.5	525	580	435	-	420
32	760	845	634	-	608
36	960	1070	803	-	768
40	1190	1320	990	-	952
47	1650	1820	1365	-	1320
<b>SAS 835/1035</b>					
57	2155	2671	-	1832	1724
65	2780	3447	-	2363	2224
75	3690	4572	-	3137	2952

## Slip values and stressing of the SAS PT system

Slip at load transfer from the prestressing jack to the anchorage (at maximum prestressing force)

Diameter $\emptyset$ [mm]	WR bars		WS bars
	After one stressing cycle	After three stressing cycles	After one stressing cycle
	s [mm]	s [mm]	s [mm]
<b>SAS 950/1050 (ETA-05/0122)</b>			
18	1.7	0.2	-
26.5	1.7	0.9	0.7
32	1.7	0.9	0.7
36	1.7	0.9	0.7
40	1.7	0.9	0.7
47	1.4	0.9	-
<b>SAS 835/1035</b>			
57	2.0	1.0	-
65	2.2	1.1	-
75	2.5	1.5	-

Prestressing of SAS post-tensioning systems may only be carried out by SAH-approved and trained PT companies. During prestressing attention must be paid to the fact that the slip in the coarse thread and fine thread leads to a loss in prestressing force. This is particularly important for short tendons (elongation: approx. 3.5mm/m) If required, the tendon must be overtensioned

in order to compensate the thread slip (Caution: The permissible maximum prestressing force according to the approval may not be exceeded!). During stressing, proper alignment of the foundation blocks must be ensured in order to prevent damage or bending in the tendons.

# Recommendations for the dimensioning of the SAS PT system

Diameter $\emptyset$ [mm]	Plate	WR bars		
		Stressing anchor	Fixed anchor	Coupling
		s [mm]	s [mm]	s [mm]
<b>SAS 950 / 1050 WR (ETA-05/0122)</b>				
<b>18</b>	Solid plate	1.5	3.2	2.0
	Solid plate, rectangular	1.0	2.7	
	Solid plate, rectangular, small			
<b>26.5</b>	Solid plate	1.5	3.2	2.0
<b>32</b>	Solid plate, rectangular	1.0	2.7	
<b>36</b>	Solid plate, rectangular, small			
<b>40</b>	QR-plate			
<b>47</b>	Solid plate	1.0	2.7	3.0
	Solid plate, rectangular			
	Solid plate, rectangular, small			
<b>SAS 835 / 1035</b>				
<b>57</b>	Solid plate	1.5	1.1	0.7
<b>65</b>	Solid plate	1.5	1.7	0.6
<b>75</b>	Solid plate	1.5	2.0	1.7
<b>SAS 950 / 1050 WS (ETA-05/0122)</b>				
<b>32</b> <b>36</b>	Solid plate	1.5	2.2	1.0
	Solid plate, rectangular	1.0	1.7	
	Solid plate, rectangular, small			

## Stress control / lift-off-test

In individual cases it may be necessary to determine the actual force in the tendon after installation. This may be done at any time by installing and stressing a jack. The moment in which the nut can be turned indicates the anchor force. The extent and frequency of testing must be specified in each individual case.

After testing, the tendons must again be prestressed up to 100% of the design force. Following such works, the proper corrosion protection must be completely restored.

Operating procedure for lift-off-test

- Please note:  
It may be necessary to pull the nut free up to max. 0.5mm,

before it can be turned. For short tendons, a certain inaccuracy may therefore be expected during the lift-off-test. This inaccuracy may be reduced by providing tightened nuts and a jack chair with movable nose as well as by repeated stressing and stress release.

According to EN 13670-1, an inaccuracy of 15% is generally permitted for each tendon; the mean deviation may however not exceed 5%.

- Operation sequence  
For the lift-off-test a calibrated jack and a pump with precision manometer must be used. First, the protective cap filled with corrosion protection compound is removed. The jack must be installed as centrally and parallel as possible to the bar axis. The pump pressure is gradually increased. The jack pressure at which the dome nut can be slightly

# Recommendations for the dimensioning of the SAS PT system

Required bar protrusions for (re-)stressable SAS post-tensioning systems

Bar diameter	Length stressing coupler WR8003	Half length stressing coupler WR8003	Recommended minimum reserve	Recommended minimum bar protrusion	Outer diameter stressing coupler
$\emptyset$	l	l/2	$\Delta l$	l + $\Delta l$	$\emptyset$
[mm]	[mm]	[mm]	[mm]	[mm]	[mm]
<b>SAS 950/1050</b>					
18	100	50	10	60	45
26,5	150	75	10	85	45
32	180	90	10	100	55
36	200	100	10	110	60
40	220	110	10	120	65
47	240	120	10	130	75
<b>SAS 835/1035</b>					
57	270	135	10	145	95
65	290	145	10	155	110
75	320	160	10	170	120

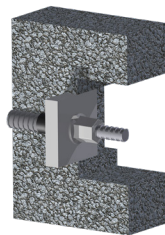
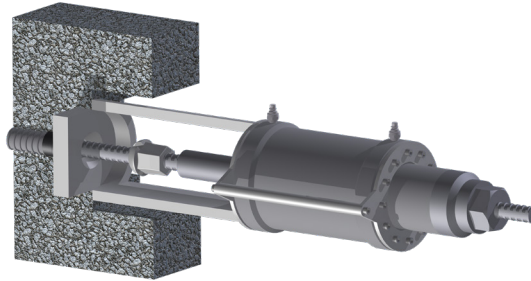

# Installation and corrosion protection system

## General

Since several months may pass between the delivery of the tendons (to the construction site) or final prestressing, only the design options are available, with “corrosion protection using heat-shrinking sleeve” or, alternatively, tendons that have been factory pre-grouted with corrosion protection compound or cement grout!

Tendons of the design option: “Corrosion protection by means of subsequent grouting” are unprotected in the installation state, without grouting, and therefore very susceptible to mechanical damage and stress corrosion cracking, thus making additional protection measures necessary (e.g. air drying or RUSTBAN 310 etc.).

Chapter “Available PT systems and corrosion protection” show examples of the design details of a bonded tendon grouted after the installation, of a tendon filled with corrosion protection compound, and of a tendon with a heat-shrinking sleeve and PE tube (without free tendon duct). In individual cases, other variations are allowed, which should however be agreed upon with a SAH-approved PT company or SAH.

## Available PT systems and corrosion protection

According to the ETA 05/0122, various options are possible:

a) Bonded bar tendon (with free tendon duct) – corrosion protection by means of subsequent grouting of the sheath



b) Unbonded bar tendon (with free tendon duct) - corrosion protection with heat-shrinking sleeve



c) Unbonded bar tendon (with free tendon duct) - corrosion protection by means of grouting using cement grout prior to stressing (DCP, only WR)

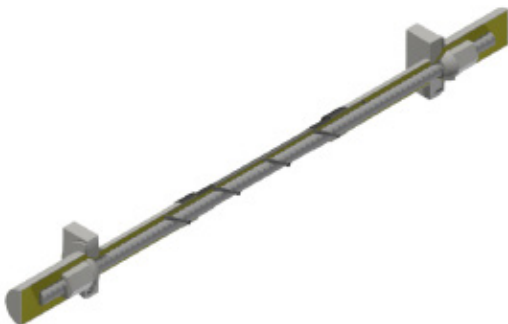

d) Unbonded bar tendons (without free tendon duct) – corrosion protection with heat-shrinking sleeve  
e) Unbonded bar tendons (without free tendon duct) – factory pre-grouted with corrosion protection compound or cement grout (cf. geotechnical rock/soil anchors)  
f) For a service life of < 2 years, systems with temporary corrosion protection can be used (not included in this planning guideline) (DCP, only WR)

# Installation and corrosion protection system

## Corrosion protection of bonded SAS bar tendons

To ensure long-term corrosion protection and bond, the annular ring between sheathing and bar tendon is grouted using highly plastic grout with thixotropic properties.

The grout is always injected at the lowest point to ensure that the air can escape freely and fully on the vent side and that the annular ring is completely filled with grout. By using special anchor nuts the grout can flow through grouting slots in the dome of the nut into the sheathing and exit on the vent side.

Prior to and during grouting, the grout properties are continuously monitored according to valid standards to guarantee long-term alkaline corrosion protection. Grouting pumps with integrated mixer are available from SAH or from SAH certified sales partners.

For bonded systems, the tendon is installed within a tendon duct and grouted following stressing. The cement grout, in addition to providing alkaline corrosion protection of the post-

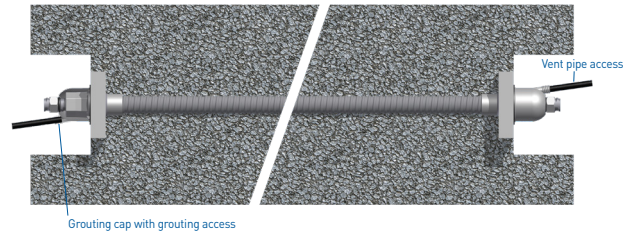

tensioning bar, also ensures a direct bond to the surrounding concrete. The grout of SAS 950/1050 systems is injected into the tendon duct or sheathing via a grout cap (S 5016) with tightening accessories (WR5005, P5018, P5019), through a domed nut with grout slots. If the dead end anchor is firmly embedded in the surrounding structural concrete, the tendon duct is vented through end caps (P 4021) adapted to suit the shape of the SAS thread and sheathing.

## Corrosions protection of unbonded SAS bar tendons

Unlike internal bonded tendons, bars filled with plastic corrosion protection compound can be restressed

or replaced at any time. To ensure complete filling of the annular ring between tendon and sheathing, the corrosion protection compound is usually preheated and injected in a liquid state.

Grouting with corrosion protection compound can be carried out at the factory. This makes it possible to also use the tendons in locations inaccessible to machines with no additional corrosion protection required.

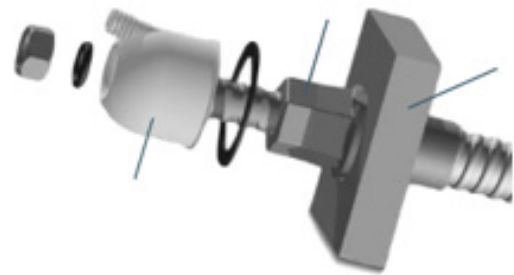

## Corrosion protection with heat-shrinking sleeve and PE tube

The thread bars are fitted with temporary and final corrosion protection using a heat-shrinking sleeve; they are additionally protected against minor mechanical damage by means of a PE tube. The exposed areas of the prestressing bars (e.g. the ends of dead end and live end anchors or couplings) not covered by a heat-shrinking sleeve receive their final corrosion protection by means of the surrounding concrete (dead end anchor) or by filling with corrosion protection compound (live end anchor or coupling).

For temporary corrosion protection of the exposed tendon areas, DIN 1054-3 7.6.3 "Post-tensioned bonded tendons" and EN 13670- 1, E. 7.6.1 apply analogously:

"If the ingress and collection of moisture (also water condensation) is prevented, the following periods until grouting are considered to be of no consequence with regard to prestressing steel corrosion:

- Up to 12 weeks between the manufacture date of the tendon and its grouting, however not more than 4 weeks of which may be free within the formwork
- Up to approx. 2 weeks following prestressing."

However, these hold periods cannot always be observed nor can contact with moisture always be prevented: The tendons are often embedded in concrete quite early after their delivery; prestressing (and grouting) however is carried out months later, when the steel structural elements are manufactured and installed.

Therefore, the exposed bar sections are fitted at the factory with temporary corrosion protection using Rostschutz 310 according to DIBt-approval Z-13.6-137.

# Installation and corrosion protection system

## Pre-assembly

Pre-assembly of the post-tensioning system, i.e. fitting the bars with heat-shrinking sleeves and PE tubes, may only be carried out by SAH-approved and trained PT companies!

The material properties of the heat-shrinking sleeves and adhesive must be verified by an inspection certificate 2.1 according to DIN EN 10204. The heat-shrinking sleeves must have a wall thickness of at least 1.5mm when shrunk-on.

To check and document the absence of pores on the heat-shrinking sleeves as well as to avoid air pockets, a yes/no inspection is carried out by an SAH commissioned and approved PT company on each steel tensile element over its entire area, in particular however at potential heat-shrinking sleeve joints, by applying a voltage of 10kV using a metal brush.

Anticorrosive heat-shrinking sleeves according to DIN EN 12068, with coating classification according to EN 12068 - C30 (e.g. PMA, CPSM), made of radiation cross-linked polyethylene and with an initial wall thickness of ~0.7mm are used, coated on the inside with an adhesive with corrosion inhibitors, base material butyl rubber.

Heat-shrinking is carried out using hot air, infrared guns or the soft flame of a gas burner. At heat-shrinking sleeve joints, where present, the heat-shrinking sleeves must overlap by at least 5cm (after heat-shrinking).

Heat-shrinking sleeve joints must always be constructed very carefully!

## Corrosion protection by means of factory pre-filling with corrosion protection compound or cement grout

For this option, the tendon is protected against low mechanical loads during installation by means of a duroplastic corrosion protection compound.

Due to the pre-assembly, it offers the same advantages as a post-tensioning system with corrosion protection by means of a heat-shrinking sleeve with PE tube.

### Pre-assembly

At the factory of the SAH-approved PT company, the tendons are already cut to their final lengths, sheathed with a PE tube; the annulus is filled with a plastic corrosion protection compound.

For filling, the compound is heated to temporarily increase its viscosity. The ends of the PE tube are fitted with grouting and vent caps or with heat-shrinking sleeves and grouting and vent adapters.

As an alternative to the corrosion protection compound, filling may also be carried out using cement grout (see pre-grouting with cement grout geotechnical anchor). To ensure free elongation during stressing, the tendon is in this case usually fitted with a double PE sheathing.

## Installation basics

The installation company must be informed in writing (and consequently already in the tender phase) on the sensitivity of the tendons during installation and importance of observing the provisions specified in the approval.

In particular, it is stated therein:

### General

It is assumed that the product will be installed according to the manufacturer`s instructions or - in absence of such instructions - according to the usual practice of building professionals.

Assembly and installation of bar tendons is only carried out by qualified PT specialist companies with the required resources and experience in the use of bar post-tensioning systems, see CWA 14646. The company`s PT site manager has a certificate, stating that she or he has been trained by the ETA holder and she or he possesses the necessary qualifications and experience with the „SAS - post-tensioning bar tendon system“.

In sufficient time prior to transport from the manufacturer to the construction site, the installation company must submit work instructions approved by the approval holder. These must

include information on transport, handling, storage, installation, prestressing and corrosion protection as well as protection against mechanical damage. This information must be kept available on the construction site at all times.

In particular, it must be observed:

After installation of the bar tendon, no further welding operations are performed at anchorages and immediate to the bar tendon.

The last provision must be extended to: “As a rule, no welding operations may be carried out in the immediate vicinity of the tendons or individual components!” In addition, the installation company should be informed in sufficient time to purchase all components of the post-tensioning system directly from a specialist company approved by SAH.

Within the scope of quality assurance, all certificates of conformity according to section 7 of the approval can be commissioned by the SAH-approved PT company and submitted prior to installation.

# Installation and corrosion protection system

## Prestressing of SAS PT bars

SAS bar tendons are prestressed using light and slim hydraulic jacks with integrated jack chairs. Due to the relatively light construction of the hydraulic jack, supporting and lifting devices are usually not required and prestressing is possible even under cramped conditions.

For prestressing, the SAS bar tendon is temporarily extended using a reusable special tensioning spindle consisting of a tensioning coupler and thread bar. After attaching the jack, a stressing nut is screwed on behind the cylinder.

By applying hydraulic pressure, the jack piston is extended and the bar tendon is prestressed to the required prestressing force. Subsequently, the anchor nut is screwed onto the anchor plate thereby anchoring the SAS bar tendon.

As the hydraulic pressure in the jack cylinder decreases, the prestressing force is transferred from the jack to the anchorage components. During the entire process, the applied prestressing force is indirectly checked by continuously measuring the bar elongation and hydraulic pressure. For bonded tendons, due to the continuous coarse thread of the SAS post-tensioning bars, the prestressing force can be increased or reduced by re-attaching the jack any time up until final grouting. Usually, prestressing is carried out from one side of the tendon. For bended tendons it is recommended to prestress from both sides to reduce friction losses.

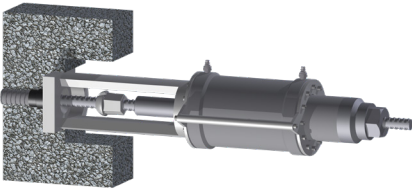

Increase of pressure in the cylinder extrusion of the piston and stressing of the tendon

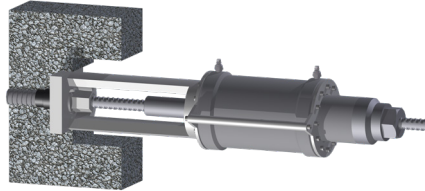

Screwing of the anchor nut towards the anchor plate and anchoring of the prestressing force

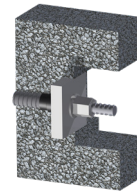

Anchor head after prestressing procedure – ready for grouting

Possible devices for stressing:

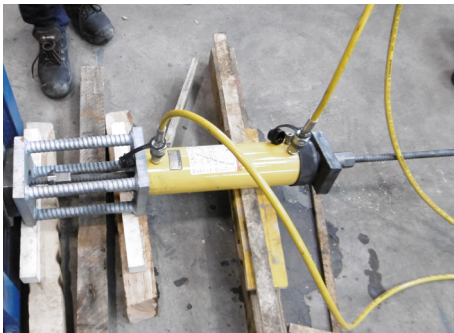

SAS PT bars can be stressed classically with a press frame and wrench. After driving the press, the nut is screwed with hexagon against the anchor plate.

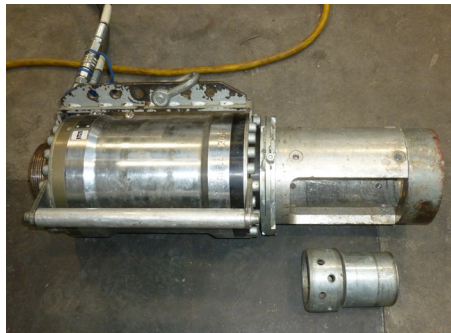

Alternatively, it is conceivable to tension the SAS PT bars with a hydraulic jack and an integrated driver sleeve. After retracting the piston rod, the hexagon of the nut is screwed by means of a driver sleeve against the anchor plate.



Also, the SAS PT bars can be stressed with presses and integrated ratchet. After retracting the piston rod, the hexagon of the nut is screwed by means of an integrated ratchet against the anchor plate.



# Installation and corrosion protection system

## Jack details

In the following table, SAH gives an overview of possible clamping jack dimensions. Of course, it is possible to switch to other types or dimensions depending on the local conditions. The decisive factor in the rule is the tension force to be applied in combination with the local geometric conditions.

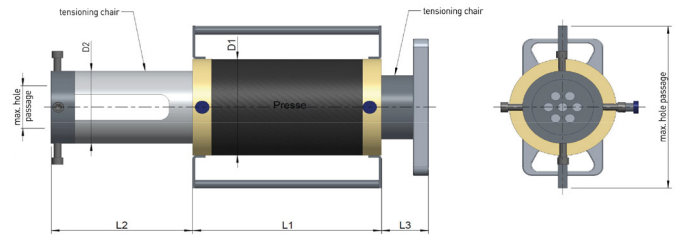

Jack	Max. Force [kN]	max.	max.	Lift [mm]	L1	L2	L3	D1 max.	D2 max.	G1	G2	G3
		hole passage	outer diameter		Jack	Chair	Terminal	Diameter chair	Diameter jack	Jack	Chair	Terminal
		[mm]	[mm]		[mm]	[mm]	[mm]	[mm]	[mm]	[mm]	[kg]	[kg]
E300KN + SP	300	33	180	60	180	250	-	115	130	10	7	-
E600KN + SP	600	54	170	80	250	260	-	170	175	27	13	-
1090KN-L + 77-193 + WE	1090	85	360	200	420	300	100	230	175	54	15	9
1090KN-S + 77-193 + SP												
1200KN-L + 77-193 + WE	1200	90	380	180	400	300	100	225	175	35	15	9
1500KN-L + 77-193 + WE	1500	120	430	250	550	300	100	280	175	150	15	10
1500KN-S + 77-193 + SP												
1700KN-L + 77-193 + WE	1700	110	430	250	500	370	100	270	175	55	15	10
2100KN-L + 77-193 + WE	2100	140	520	250	560	370	100	330	240	215	30	15
2100KN-S + 77-193 + SP												
2700KN-L + 77-193 + WE	2700	150	510	250	480	460	100	330	140	93	57	25
3000KN-L + 77-220 + WE	3000	150	500	280	580	460	100	330	215	230	72	25
3000KN-L + 77-220 + WE				460	770					365		
3500KN-L + 77-220 + WE	3500	155	520	250	580	490	100	390	230	300	72	28

## Handling instructions

### Transport and storage

Prestressing bars are high-quality construction products and must therefore be handled much more carefully than reinforcement steel. This applies both to transport and storage as well as to installation. The accessories as well must be handled very carefully in order to prevent problems during installation, stressing and grouting.

If the prestressing bars or post-tensioning systems are delivered in bulk without factory-applied corrosion protection (bonded post-tensioning), the following instructions must be observed:

- Handle the prestressing bars with utmost care during transport and unloading.
- Protect the prestressing bars against damage, soiling and moisture. Prestressing bars may only be transported in closed or covered vehicles in order to protect the bars from weather and de-icing salt damage.

- In case of a longer transport or storage time exceeding one week after the point of shipment or possible corrosion inducing climate (e.g. oversea transport) the prestressing bars shall be protected temporary with factory applied corrosion protection (e.g. rust-ban, Rostschutz 310)
- The vehicles used must be free of aggressive chemicals such as chlorides, nitrates, fertilizers, acids etc.

In addition, the following instructions must be observed:

- The prestressing bars may only be loaded and unloaded using e.g. hemp or steel-reinforced nylon ropes. Steel ropes are permissible only if squared timbers are used.
- Do not unload the prestressing bars by tipping the vehicle.
- Do not throw off or drop the prestressing bars onto the ground.
- The prestressing bars may not be welded nor may welding be executed close to the prestressing bars in order to avoid weld spatters.

## Protection against corrosion damage on the construction site

Prestressing bars must be protected against moisture and humidity in order to prevent corrosion damage. Flash rust, i.e. rust which can be wiped off with a soft dry cloth or a soft brush, is harmless. Rust-pitted prestressing bars may not be used.

- The prestressing bars may only be transported with suitable covering.
- The prestressing bars must be stored until installation in covered dry areas or covered by impermeable tarpaulin or plastic foils.
- Prevent the formation of condensation! Ensure sufficient ventilation! Make sure that there is no direct contact between the prestressing bars and plastic foil.

- Do not store the prestressing bars in direct contact with the ground; insert squared timbers to ensure sufficient clearance to the ground.
- Do not store the prestressing bars in the vicinity of aggressive chemicals such as chlorides, nitrates, fertilizers, acids, road salt etc.
- The prestressing bars must be grouted with cement grout immediately after installation and stressing (bonded post-tensioning). If grouting is to be delayed, the prestressing bars must be coated using an approved corrosion inhibitor prior to installation. UngROUTED tendon ducts must be protected against the ingress of water.

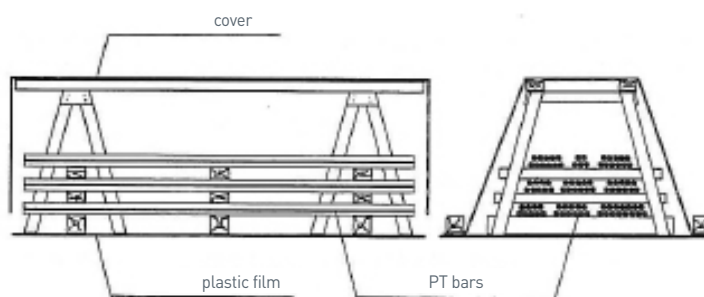

Figure: Storage of prestressing bars

## Protection of the prestressing bars against damage

Surface damage such as notches, deep scratches and kinks must be avoided. Damaged prestressing bars may not be installed. Careful handling of the prestressing bars must be ensured.

- Load and unload the prestressing bars e.g. using hemp or steel-reinforced nylon ropes. Steel ropes are permissible; it is recommended to use squared timbers additionally.

- Do not unload the prestressing bars by tipping the vehicle.
- Do not throw the prestressing bars from the vehicle.
- Do not drag the prestressing bars over sharp edges.
- Avoid surface damage resulting from the use of pipe wrenches, chisels, saws, files or similar sharp tools.
- Always use squared timbers for storing several layers of prestressing bars.

## Heat protection

Acute heat exposure of even very small areas causes embrittlement or reduces the steel strength and must therefore be prevented.

- The prestressing bars shall not be welded (including tack welding)
- The prestressing bars must be protected from welding heat, weld spatter and hot welded objects.
- The prestressing bars or their casings may not be used as ground conductors for electric equipment. Risk of spark-over!
- The prestressing bars may not be subjected to pre-bending. Cold bending is permitted, but only in a continuous bending operation up to the specified radii using prestressing steel bending machines approved by SAH.
- The prestressing bars may only be cut using plastic-bonded cutting discs.

The carrier must receive these instructions and strictly observe them (see page D1.0-10 and following pages). The two-page information leaflet "Transport instructions for prestressing bars" filled out and signed by the person collecting the bars must be submitted to the recipient.

If the prestressing bars are provided with factory-applied corrosion protection (e.g. unbonded post-tensioning systems – corrosion protection with heat-shrink sleeves) the following additional instructions must be observed:

- The factory-applied corrosion protection must be protected against damage during transport, storage and installation.
- Carry out a visual inspection of the corrosion protection prior to installing the tendons.
- SAH must be informed of any damages to the corrosion protection. Such tendons must be replaced or, after consulting SAH, professionally repaired. SAH will supply the respective repair instructions in each individual case.



# Handling instructions

## Installation/handling

During installation, the tendons must be aligned using templates (with permissible steel construction tolerances of approx. +/- 1 mm). The templates must be arranged at least at the dead end anchor (e.g. above the coupling of the anchor plates) and at the live end anchor (above the coupling of the transition tubes). For longer tendons or inclined/horizontal lay-outs, additional templates must be used to prevent the tendons from buckling or sagging. During concrete placement, it must be ensured that the tendons are neither subjected to transverse loads during pouring nor deformed by the vibrators!



The position and orientation of the tendons should be measured by a gauge, the measuring protocols should be available prior to concrete placing! The connection detail at the live end anchor allows maximum construction tolerances of approx. +/- 15mm! During the period between the placing of concrete and prestressing/filling (application of the final corrosion protection at the live end anchor), the tendon heads must be completely protected against weather influences (e.g. by wrapping with DENSO tape) and mechanical damage (e.g. using steel plate housings)!

## Design guide SAS 950/1050

  	
<b>European Technical Assessment</b> <span style="float: right;"><b>ETA-05/0122</b> of 09.12.2019</span>	
General part	
<b>Technical Assessment Body issuing the European Technical Assessment</b>	Österreichisches Institut für Bautechnik (OIB) Austrian Institute of Construction Engineering
<b>Trade name of the construction product</b>	SAS – Post-tensioning bar tendon system
<b>Product family to which the construction product belongs</b>	Bonded, unbonded, and external post-tensioning kits for prestressing of structures with bars, diameter 17.5 to 47 mm
<b>Manufacturer</b>	Stahlwerk Annahütte Max Aicher GmbH & Co. KG 83404 Ainring-Hammerau Germany
<b>Manufacturing plant</b>	Stahlwerk Annahütte Max Aicher GmbH & Co. KG 83404 Ainring-Hammerau Germany
<b>This European Technical Assessment contains</b>	78 pages including Annexes 1 to 47, which form an integral part of this assessment.
<b>This European Technical Assessment is issued in accordance with Regulation (EU) № 305/2011, on the basis of</b>	European Assessment Document (EAD) 160004-00-0301 – Post-Tensioning Kits for Prestressing of Structures.
<b>This European Technical Assessment replaces</b>	European Technical Assessment ETA-05/0122 of 27.06.2018.

Aids for the design and construction of the SAS PT system are regulated in the European approval ETA-05/0122 and presented in great detail. Therefore, reference is made to the relevant document at this point.

In addition, ETA-12/0601 regulates the use of the SAS 950/1050 when used as a rock and ground anchor:

  	
<b>European Technical Assessment</b> <span style="float: right;"><b>ETA-12/0601</b> of 21.12.2018</span>	
General part	
<b>Technical Assessment Body issuing the European Technical Assessment</b>	Österreichisches Institut für Bautechnik (OIB) Austrian Institute of Construction Engineering
<b>Trade name of the construction product</b>	Rock and soil anchor system SAS with prestressing steel thread bars Y1050H, diameter 17.5 to 47 mm
<b>Product family to which the construction product belongs</b>	Kit for rock and soil anchors – Kit with thread bars of prestressing steel
<b>Manufacturer</b>	Stahlwerk Annahütte Max Aicher GmbH & Co. KG 83404 Ainring-Hammerau Germany
<b>Manufacturing plant</b>	Stahlwerk Annahütte Max Aicher GmbH & Co. KG 83404 Ainring-Hammerau Germany
<b>This European Technical Assessment contains</b>	49 pages including Annexes 1 to 28, which form an integral part of this assessment.
<b>This European Technical Assessment is issued in accordance with Regulation (EU) № 305/2011, on the basis of</b>	EAD 160045-00-0102, European Assessment Document for Kit for rock and soil anchors – Kit with thread bars of prestressing steel.
<b>This European Technical Assessment replaces</b>	European technical approval ETA-12/0601 with validity from 12.06.2013 to 11.06.2018.

## Post-tensioning system example with dome nut

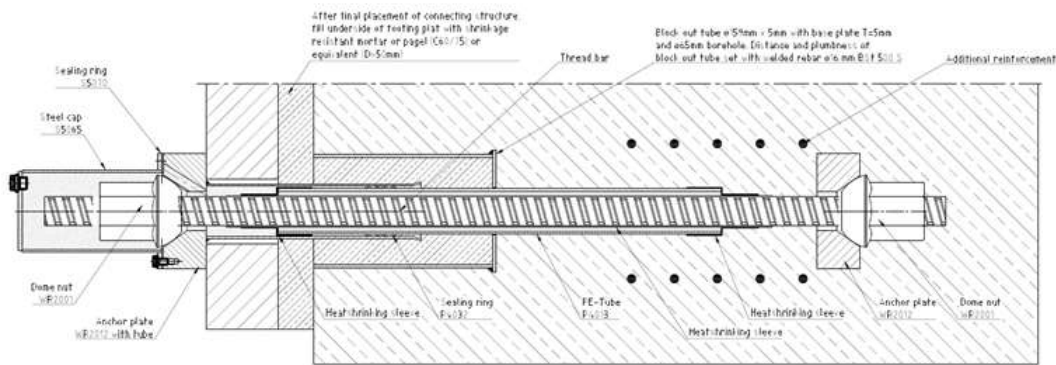

Fig.: Design detail – Unbonded tendon (without free tendon duct) factory pre-filled with corrosion protection compound, see also ETA-05/0122

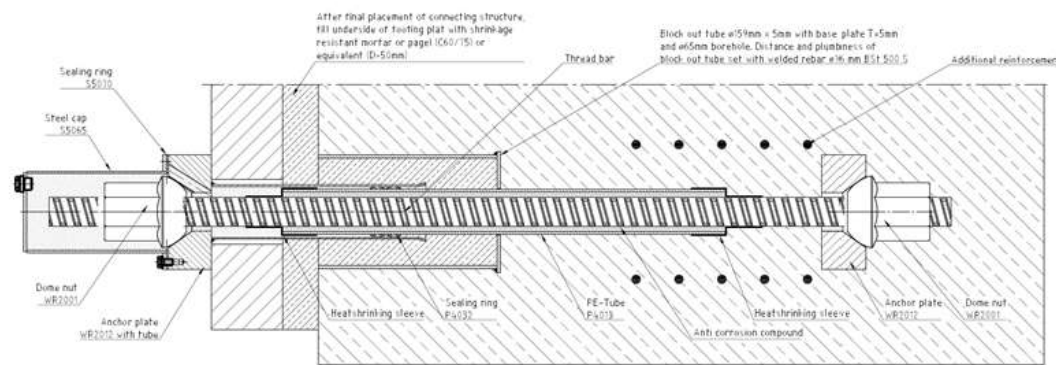
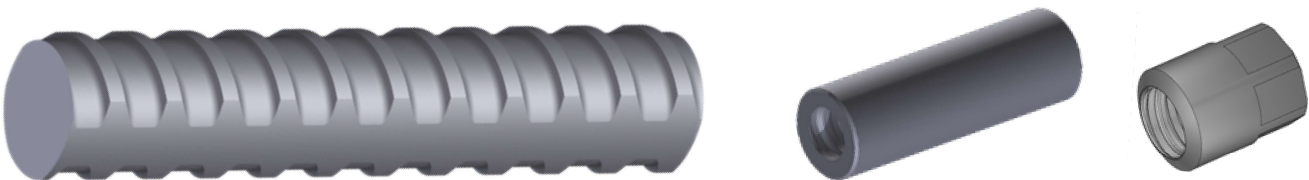

Fig.: Design detail – unbonded tendon with heat-shrinking sleeve and PE tube (without free tendon duct), see also ETA-05/0122

## Design guide SAS 835/1035

### Prestressing bar system – Mechanical and technological characteristics



Mechanical and technological characteristics			
Characteristic yield strength bar	$F_{p0.1k}$	[N/mm <sup>2</sup> ]	835
Characteristic tensile strength bar	$F_{pk}$	[N/mm <sup>2</sup> ]	1035
Elongation at maximum force bar	$A_{gt}$	[%]	≥ 4
Fatigue resistance bar at an upper stress of $\sigma_{up} = 0.7 \cdot R_{m,act}$ up to $2 \cdot 10^6$ load cycles	$2 \sigma_A$	[N/mm <sup>2</sup> ]	120
Fatigue resistance nut and coupler at an upper stress of $\sigma_{up} = 0.65 \cdot R_{m,nom}$ up to $2 \cdot 10^6$ load cycles	$2 \sigma_A$	[N/mm <sup>2</sup> ]	35
Isothermal relaxation acc. EN 15630-3	Losses from initial force of $0.7 \cdot F_{m,a}$ after 1,000 h		≤ 4%
Stress corrosion resistance within a test series at a stress of $0.8 \cdot R_{m,act}$ Ø57 mm, duration of fracture a) individual result b) median	a)	[h]	100
	b)	[h]	400
Bond strength bar with a compressive strength of cement mortar ≥ 40 N/mm <sup>2</sup>	$f_b$	[N/mm <sup>2</sup> ]	6
E-Modulus	E	[GPa]	205

Prestressing steel bar	Force at yield strength	Maximum force
Ø	$F_{p0.1k}$	$F_{pk}$
[mm]	[kN]	[kN]
57	2155	2671
65	2790	3447
75	3690	4572

# Design guide SAS 835/1035

## Prestressing bar system – Design forces

Design forces acc. to Eurocode 2 and Eurocode 7					
Force	Ø	[mm]	57	65	75
Characteristic force at yield strength	$F_{p0.1k}$	[kN]	2155	2790	3690
Characteristic maximum force	$F_{pk}$	[kN]	2671	3447	4572
Maximum lock-off force 85%· $F_{p0.1k}$	-	[kN]	1832	2372	3137
Maximum stressing force* 95%· $F_{p0.1k}$	-	[kN]	2047	2651	3506
Maximum stressing force 90%· $F_{p0.1k}$	-	[kN]	1940	2511	3321

\* 95%· $F_{p0.1k}$  can only be applied, if the force in the prestressing jack can be measured to an accuracy of +/- 5% of the final value of the proof force.

## Post-tensioned systems

### Anchor nut flat, bull nose nut 30°

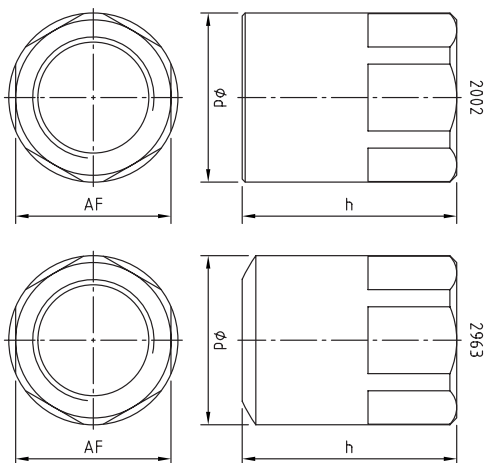

Prestressing steel bar	Designation	WR 2002/WR 2963		
		AF	h	d
Thread bar	Ø 57	90	120	95
	Ø 65	100	130	106
	Ø 75	105	145	114

### Coupler

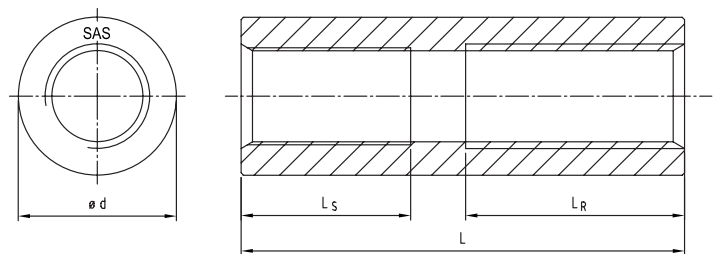

Prestressing steel bar	Designation	WR 3003	
		d	L
Thread bar	Ø 57	95	240
	Ø 65	106	260
	Ø 75	114	290

## Mechanical anchorage WITH additional bursting reinforcement

Actual concrete compressive strength at time of stressing,  $F_{cm,0,cube150} \geq 37 \text{ N/mm}^2$ . Minimum concrete compressive strength class according EN 206-1  $\geq \text{C30/37}$ . Reinforcement in the anchorage zone  $\geq 50 \text{ kg/m}^3$  (not to be detailed and placed as bursting reinforcement).

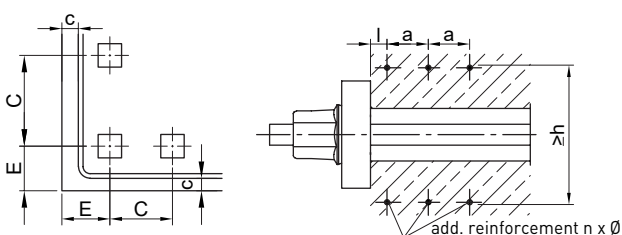

- n: Number of stirrups
- Ø: Nominal diameter of stirrups
- a: Axis spacing of additional reinforcement
- l: Distance of first stirrup to anchor plate
- h: External dimensions of stirrups

Thread bar diameter	Centre spacing	Edge distance	Maximum hole diameter	Additional reinforcement Helix	
$\emptyset$	C	E	$\emptyset_s$	$n \times \emptyset / a / l$	$\emptyset$ (helix)
[mm]	[mm]	[mm]	[mm]	[ ] x [mm] / [mm] / [mm]	[mm]
57	520	250	114,3	7 x 14 / 50 / 30	350
65	735	360	114,3	8 x 14 / 50 / 30	400
75	950	465	133,0	9 x 14 / 50 / 30	450

All given data is to be understood purely as recommendation based on FEM calculations. These recommendations do not replace an approval and do not reflect normative rules. Since no actual test results are available, SAH cannot give any warranty.

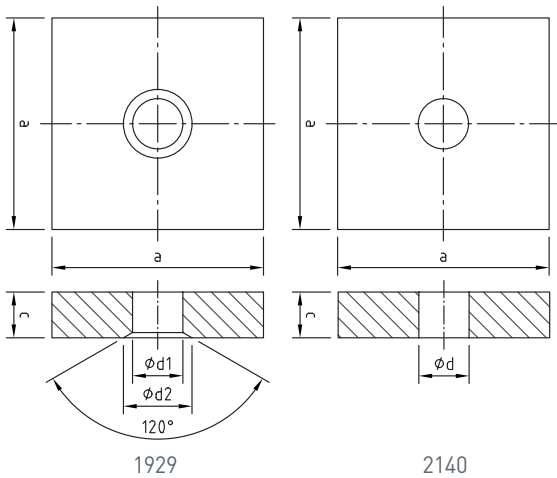

Prestressing steel bar	Designation	WR 2140			WR 1929		
		a	c	d	a	c	d
Thread bar	$\emptyset$ 57	220	50	70	220	50	70
	$\emptyset$ 65	245	60	78	245	60	78
	$\emptyset$ 75	275	70	88	275	70	88

Material: S355 or higher

## Mechanical anchorage WITHOUT additional bursting reinforcement

Actual concrete compressive strength at time of stressing,  $F_{cm,0,cube150} \geq 25 \text{ N/mm}^2$ . Minimum concrete compressive strength class according EN 206-1  $\geq \text{C20/25}$ . Reinforcement in the anchorage zone  $\geq 50 \text{ kg/m}^3$  (not to be detailed and placed as bursting reinforcement).

Thread bar diameter	Centre spacing	Edge distance	Maximum hole diameter
$\emptyset$	C	E	$\emptyset_s$
[mm]	[mm]	[mm]	[mm]
57	800	390	114,3
65	920	450	114,3
75	1100	540	133,0

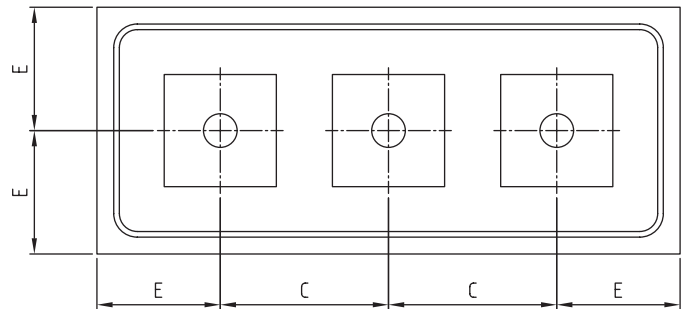

All given data is to be understood purely as recommendation based on FEM calculations. These recommendations do not replace an approval and do not reflect normative rules. Since no actual test results are available, SAH cannot give any warranty.

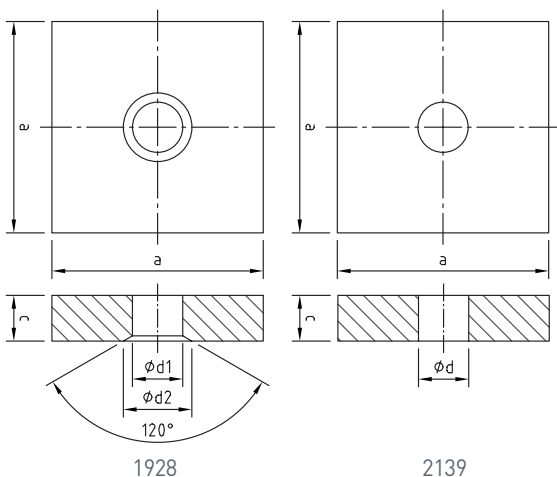

Prestressing steel bar	Designation	WR 2139			WR 1928			
		a	c	d	a	c	d1	d2
Thread bar	$\emptyset$ 57	285	65	70	285	65	70	90
	$\emptyset$ 65	325	70	78	325	70	78	110
	$\emptyset$ 75	370	80	88	370	80	88	120

Material: S355 or higher

# Design guide SAS 835/1035

## Stressing and fixed anchor | Bonded bar tendons

Stressing anchor and fixed anchor, accessible on both anchorages

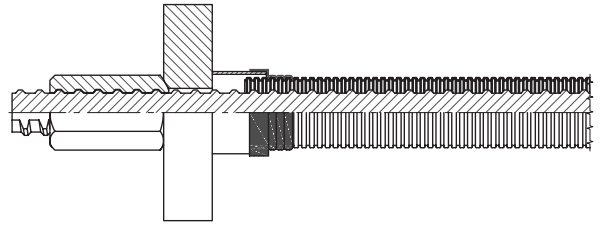
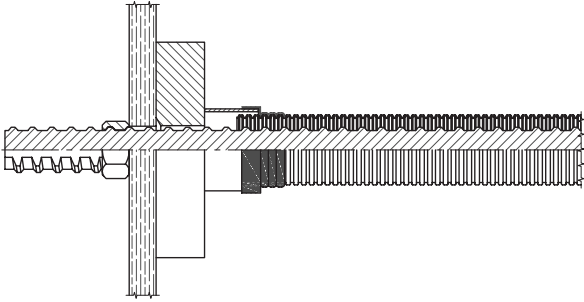

Fixed anchor, embedded in concrete

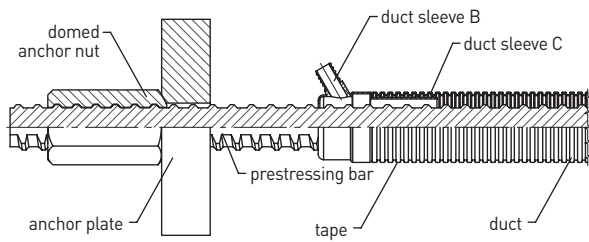

Stressing anchor and fixed anchor

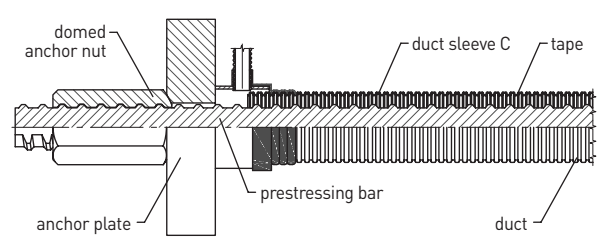

## Stressing and fixed anchor | Unbonded bar tendons

Stressing anchor and fixed anchor, accessible on both anchorages

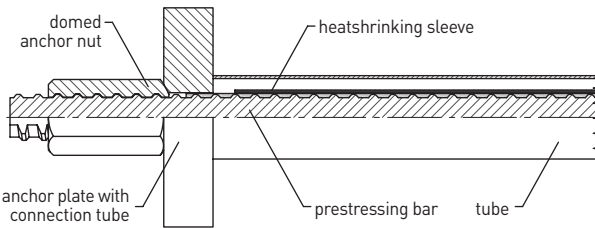

Fixed anchor embedded in concrete

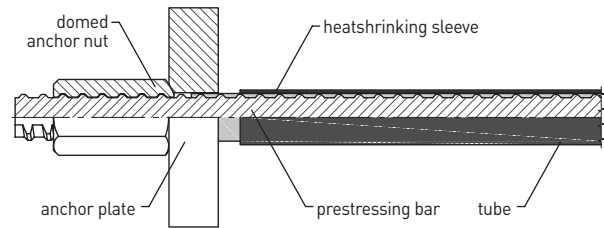

## Movable coupling

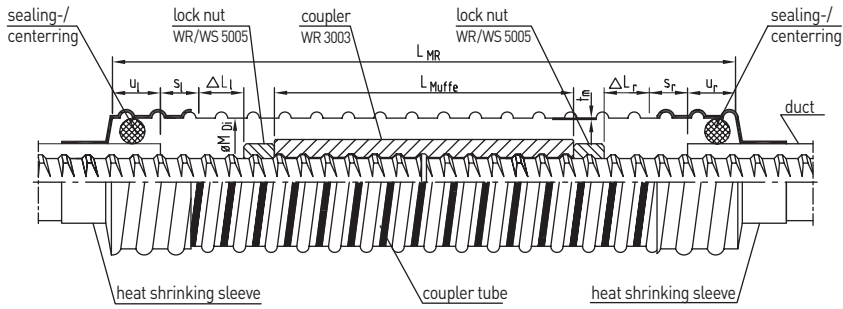

- $L_{Mr} = L_{Muffe} + \Delta L_L + \Delta L_R + s_L + s_R + u_L + u_R$   
 $L_{Mr}$ : length of coupler tube  
 $L_{Muffe}$ : length of coupler/transition coupler  
 $\Delta L_L, \Delta L_R$ : movement of coupler on left and right respective  
 $s_L, s_R$ : safety clearance,  $0.2 \cdot \Delta L \geq 40\text{mm}$   
 $u_L, u_R$ : coupler tube protusion on left and right respective

Designation		Ø57	Ø65	Ø75
min Ø M <sub>Di</sub>	[mm]	110	120	130
Thickness of the metal sheet	[mm]	0.3	0.3	0.3

## Post-tensioning system example with bull nose nut

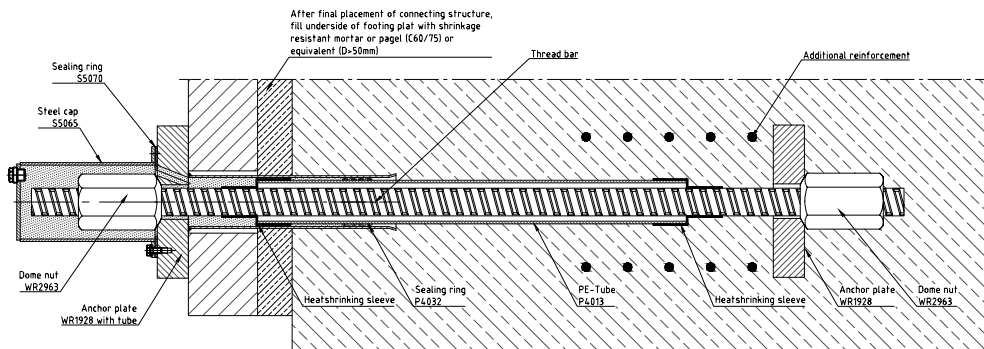

Fig.: Design detail – Unbonded tendon (without free tendon duct) factory pre-filled with corrosion protection compound, see also ETA-05/0122

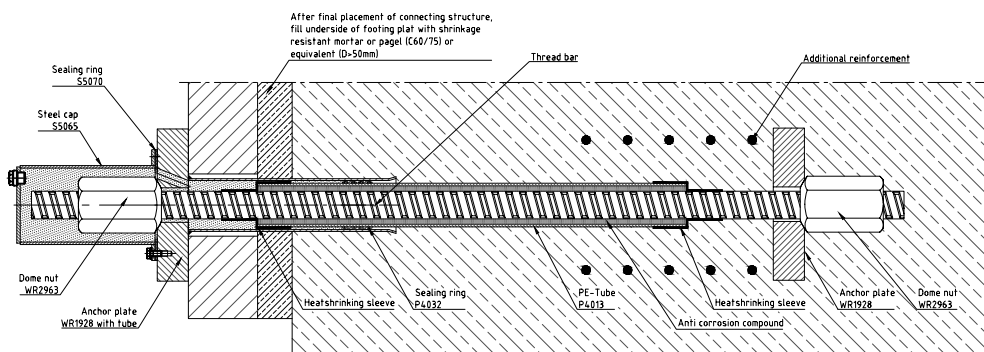

Fig.: Design detail – unbonded tendon with heat-shrinking sleeve and PE tube (without free tendon duct), see also ETA-05/0122



# Design guide SAS 835/1035

## Rock and soil anchors

### Tendon with free tendon duct | Temporary corrosion protection

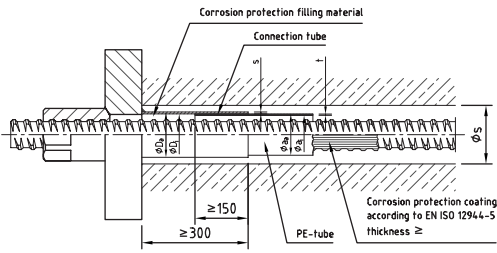

Designation		57 WR	65 WR	Ø75
Connection tube	max. ØD <sub>a</sub>	101.6	101.6	127.0
	min. ØD <sub>i</sub>	80	95	115
	recommended	101.6x2.9	101.6x2.9	101.6x3.2
PE-tube	max. Øa <sub>a</sub>	90	80	110
	min. Øa <sub>i</sub>	65	75	90
	recommended	75x4.3	90x5.4	110x6.6
Tendon duct diameter at the anchorage	max. Øs	114.3	114.3	133

### Tendon with free tendon duct | Permanent corrosion protection | Grouting before installation

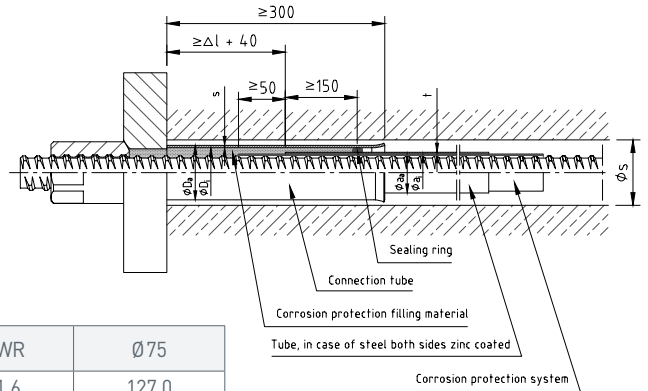
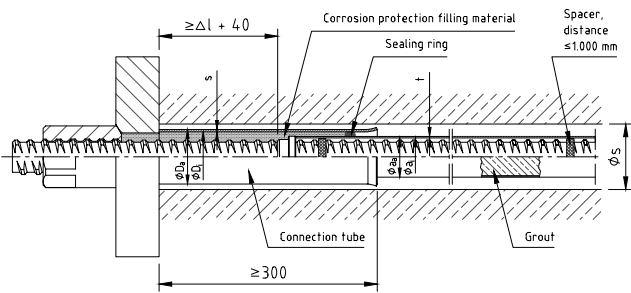

Bar designation		57 WR	65 WR	Ø75
Connection tube	max. ØD <sub>a</sub>	101.6	101.6	127.0
	min. ØD <sub>i</sub>	80	95	115
	recommended	101.6x2.9	101.6x2.9	127.0x3.2
Steel tube	max. Øa <sub>a</sub>	88.9	88.9	114.3
	min. Øa <sub>i</sub>	70	80	100
	recommended	76.1x2.6	88.9x2.9	114.3x3.2
PE-tube	max. Øa <sub>a</sub>	90	100	110
	min. Øa <sub>i</sub>	65	75	90
	recommended	75x4.3	90x5.4	110x6.6
Tendon duct diameter at the anchorage	max. Øs	114.3	114.3	133

### Tendon with free filling material duct | Permanent corrosion protection

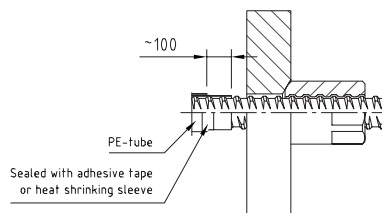
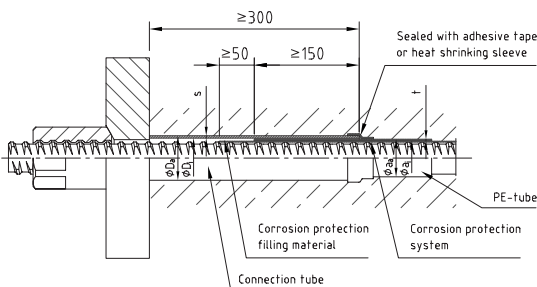

Bar designation		57 WR	65 WR	Ø75
Connection tube	max. ØD <sub>a</sub>	101.6	101.6	127.0
	min. ØD <sub>i</sub>	80	95	115
	recommended	101.6x2.9	101.6x2.9	127.0x3.2
PE-tube	max. Øa <sub>a</sub>	90	100	110
	min. Øa <sub>i</sub>	65	75	90
	recommended	90x5.4	90x5.4	110x6.6
Tendon duct diameter at the anchorage	max. Øs	114.3	114.3	133

### Anchorage - Corrosion protection

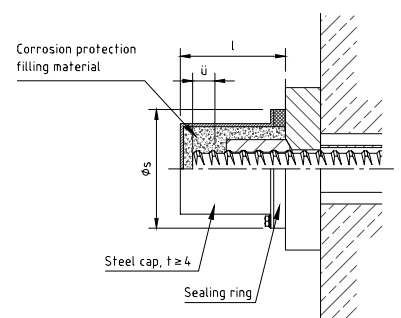

# Design guide SAS 835 / 1035

## Rock and soil anchors

### Temporary rock and soil anchor

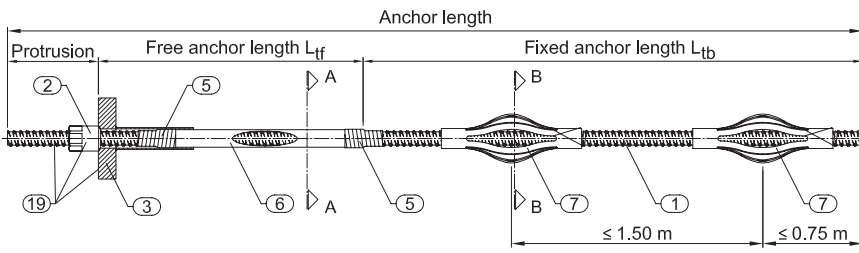

### Angle compensation with tube

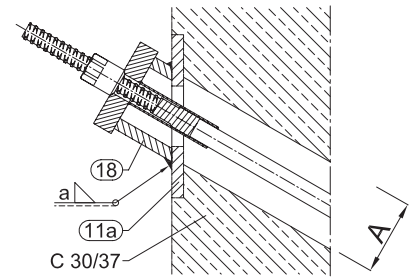

### Anchor head variants

#### Steel bearing

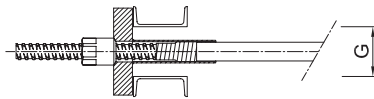

#### Fully concreted

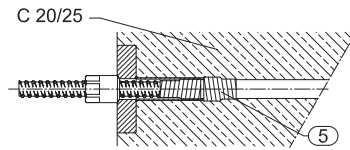

#### Bearing on larger borehole or distance

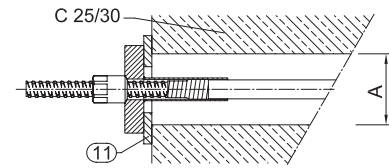

- 1: prestressing steel thread bar
- 2: bull nose nut
- 3: anchor plate with steel tube
- 5: adhesive tape
- 6: smooth sheathing
- 7: basket spacer
- 11: load transfer plate
- 11a: load transfer plat for angle compensation tube
- 18: angle compensation tube
- 19: corrosion protection coating

PT bar $\varnothing$	Max. G for bearing in steel	Min. borehole			
		anchor head	without coupler	with coupler ltb	with coupler ltf
[mm]	[mm]	[mm]	[mm]	[mm]	[mm]
57	150	115	90	120	130
65	160	115	105	130	145
75	170	135	125	140	145

### Temporary rock and soil anchor

#### Extended working life

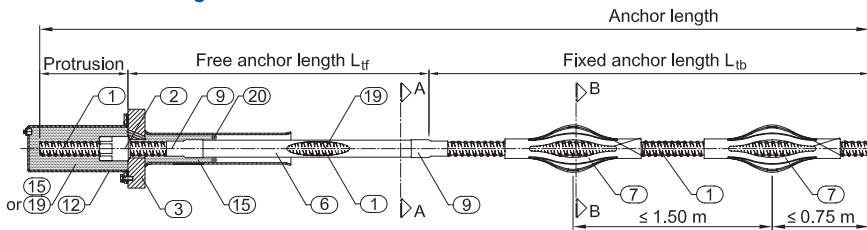

### Angle compensation with tube

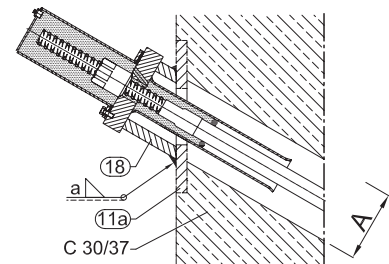

### Anchor head variants

#### Steel bearing

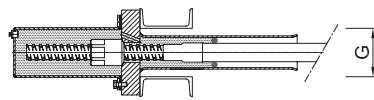

#### Fully concreted

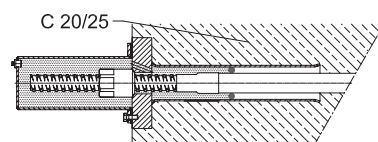

#### Bearing on larger borehole or distance

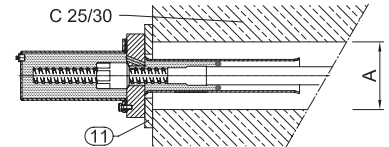

- 1: prestressing steel thread bar
- 2: bull nose nut
- 3: anchor plate with steel tube
- 6: smooth sheathing
- 7: basket spacer
- 9: heat shrinking sleeve
- 11: load transfer plate
- 11a: load transfer plat for angle compensation tube
- 12: steel-/plastic cap
- 15: corrosion protection grease
- 18: angle compensation tube
- 19: corrosion protection coating
- 20: sealing ring

PT bar $\varnothing$	Max. G for bearing in steel	Min. borehole			
		anchor head	without coupler	with coupler ltb	with coupler ltf
[mm]	[mm]	[mm]	[mm]	[mm]	[mm]
57	150	135	90	120	135
65	160	135	105	130	135
75	170	150	125	140	150

# Design guide SAS 835/1035

## Rock and soil anchors

### Permanent rock and soil anchor

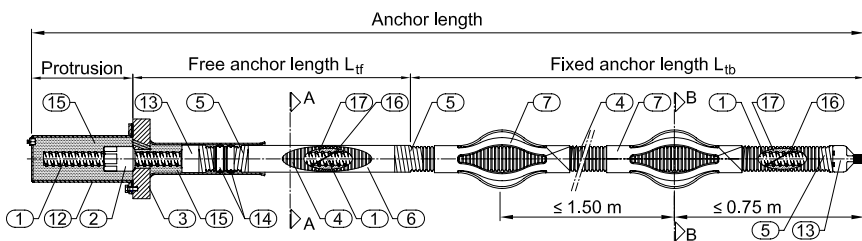

### Angle compensation with tube

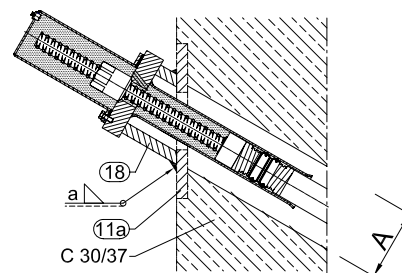

### Anchor head variants

#### Steel bearing

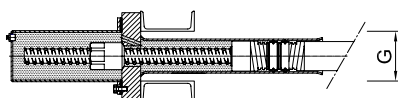

#### Fully concreted

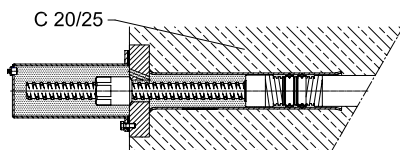

#### Bearing on larger borehole or distance

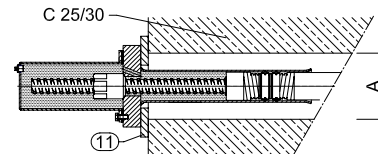

- 1: prestressing steel thread bar
- 2: bull nose nut
- 3: anchor plate with steel tube
- 4: corrugated sheathing
- 5: adhesive tape
- 6: smooth sheathing
- 7: basket spacer
- 11: load transfer plate
- 11a: load transfer plat for angle compensation tube
- 12: steel- / plastic cap
- 13: injection- and end cap
- 14: profile ring
- 15: corrosion protection grease
- 16: inner spacer
- 17: innnser cement grout
- 18: angle compensation tube

PT bar $\varnothing$	Max. G for bearing in steel	Min. borehole			
		anchor head	without coupler	with coupler ltb	with coupler ltf
[mm]	[mm]	[mm]	[mm]	[mm]	[mm]
57	150	130	120	120	145
65	160	130	120	130	145
75	170	150	135	140	160

## Accessories – (double) corrosion protection for rock and soil anchors

### Steel cap

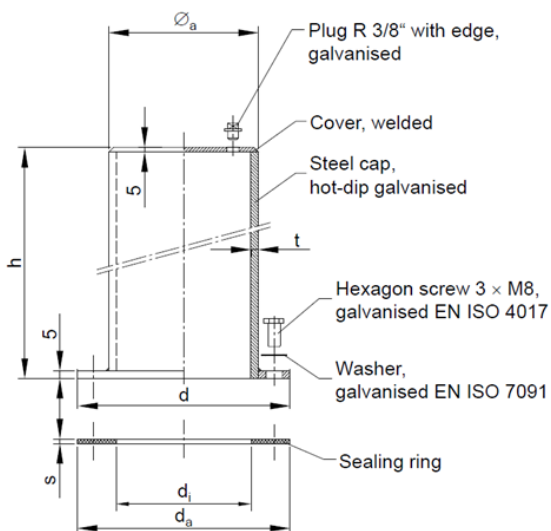

PT bar $\varnothing$	Steel tube $\varnothing_o \times t$	Flange d	Height h	Sealing ring $\varnothing_o \times \varnothing_i \times s$
[mm]	[mm]	[mm]	[mm]	[mm]
57	152.4x3.6	205	$\geq 200$	205x144x3
65	168.3x3.6	220	$\geq 200$	220x161x3
75	203.0x5.0	260	$\geq 200$	260x195x3

# Design guide SAS 835 / 1035

## Accessories – (double) corrosion protection for rock and soil anchors

### Coupling assemblies for rock and soil anchors

Coupling assemblies – Temporary rock and soil anchor  
Transition free anchor length  $L_{tf}$  – fixed anchor length  $L_{tb}$

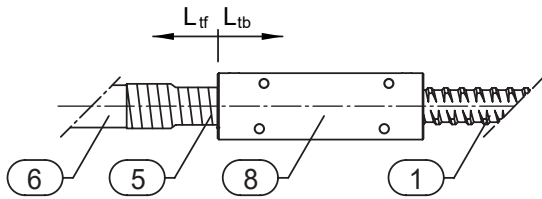

In free anchor length  $L_{tb}$

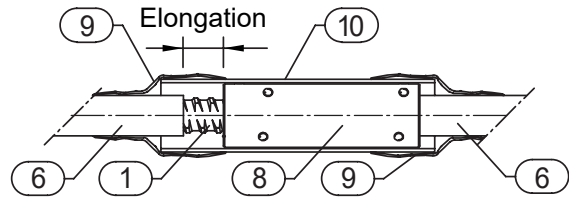

Coupling assemblies – Temporary rock and soil anchor with extended working life

Transition free anchor length  $L_{tf}$  – fixed anchor length  $L_{tb}$

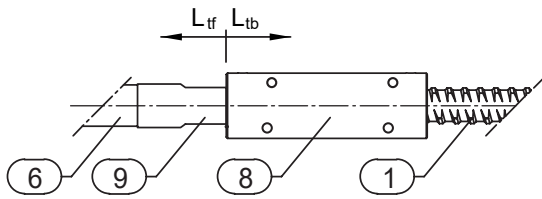

In free anchor length  $L_{tb}$

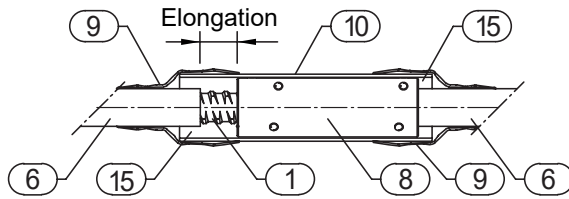

Coupling assemblies – Permanent rock and soil anchor

In free anchor length  $L_{tf}$

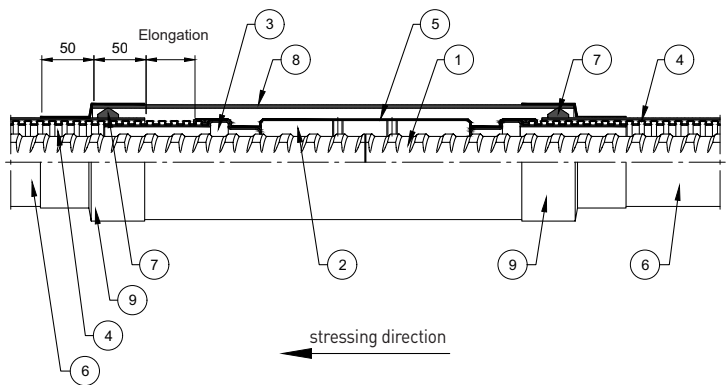
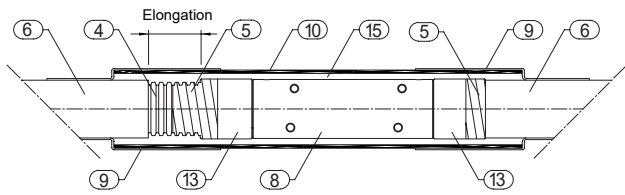

- 1: prestressing steel bar
- 4: corrugated sheathing
- 5: adhesive tape
- 6: smooth sheathing
- 8: coupler with set screws
- 9: heat shrinking sleeve
- 10: coupler tube
- 13: injection- and or end cap
- 15: corrosion protection grease

### Coupler at transition

Free anchor length  $L_{tf}$  to fixed anchor length  $L_{tb}$

The coupler is protected with a double layer of heat shrinking sleeve. Overlap of heat shrinking sleeve and adjacent elements i.e. thread bar or corrugated plastic sheathing, is at least 75 mm

Coupler in fixed anchor length  $L_{tb}$

In the fixed anchor length coupler are avoided. If a coupler is required in an exceptional case, the coupler is protected with a double layer of heat shrinking sleeve. Overlap of heat shrinking sleeve and adjacent elements i.e. thread bar or corrugated plastic sheathing, is at least 75 mm.

# Design guide SAS 835/1035

## Accessories – (double) corrosion protection for rock and soil anchors

### Coupler tube

PT bar $\varnothing$	Temporary, temporary with extended working life $\varnothing_o / \varnothing_i$	Permanent $\varnothing_o / \varnothing_i$	Length l	Thickness $\varnothing_o \times \varnothing_i \times s$
[mm]	[mm]	[mm]	[mm]	[mm]
57	110 / 105	125 / 120	600	2.5
65	125 / 120	125 / 120	600	2.5
75	125 / 125	140 / 132	600	2.5

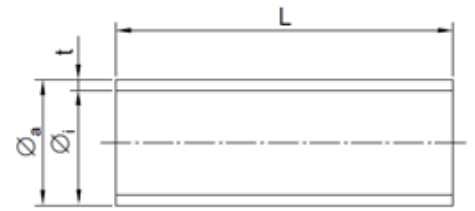

### Corrugated sheathing

PT bar $\varnothing$	Dimensions	
	Diameter $\varnothing_o / \varnothing_i$	Thickness t
[mm]	[mm]	[mm]
57	100 / 90	1.0
65	100 / 90	1.0
75	114 / 100	1.0

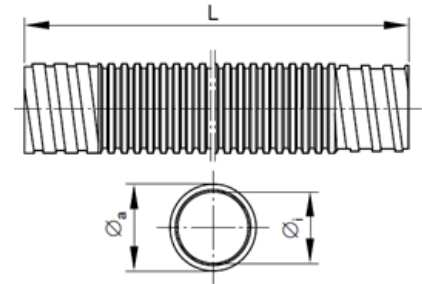

### Smooth sheathing - temporary, temporary with extended working life

PT bar $\varnothing$	Dimensions	
	Diameter $\varnothing_o$	Thickness t
[mm]	[mm]	[mm]
57	75	4.5
65	90	5.4
75	110	6.6

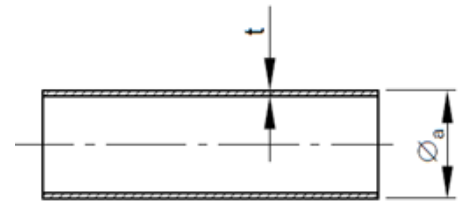

### Smooth sheathing - temporary, temporary with extended working life

PT bar $\varnothing$	Dimensions	
	Diameter $\varnothing_o$	Thickness t
[mm]	[mm]	[mm]
57	105.8	1.7
65	105.8	1.7
75	119.7	1.7

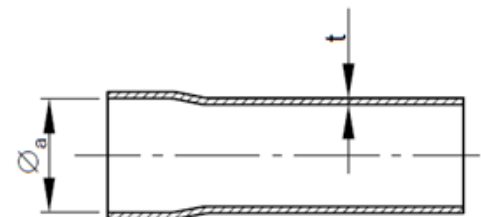

### Basket spacer

PT bar $\varnothing$	Temporary, temporary with extended working life			Permanent		
	dxs	A	L	dxs	A	L
[mm]	[mm]	[mm]	[mm]	[mm]	[mm]	[mm]
57	63x3.0	$\geq 125$	250 - 290	110x3.2	$\geq 140$	250 - 290
65	75x3.6	$\geq 125$	250 - 290	110x3.2	$\geq 140$	250 - 290
75	90x2.7	$\geq 125$	250 - 290	125x3.7	$\geq 190$	250 - 290

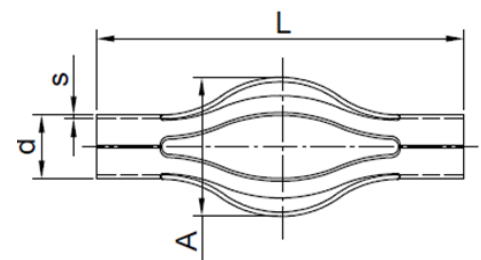

# Design guide SAS 835 / 1035

## Accessories – (double) corrosion protection for rock and soil anchors

### Profile ring

PT bar $\varnothing$	Dimensions		
	Diameter $\varnothing_o$	Diameter $\varnothing_i$	Width b
[mm]	[mm]	[mm]	[mm]
57	109	92.5	21
65	109	92.5	21
75	127	104	28

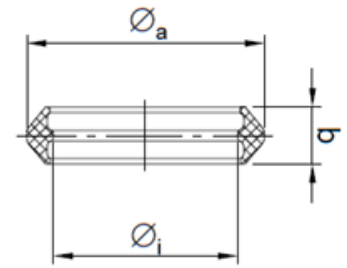

### Sealing ring

PT bar $\varnothing$	Dimensions		
	Diameter $\varnothing_o$	Diameter $\varnothing_i$	Width b
[mm]	[mm]	[mm]	[mm]
57	109	73	18
65	112	88	12
75	120	108	12

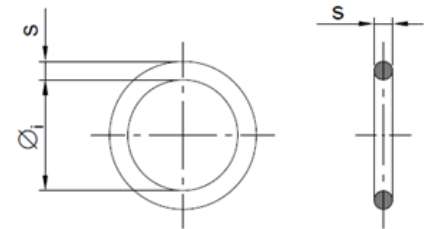

### Inner spacer (PE cord, pitch $\leq 0.5$ m)

PT bar $\varnothing$	PE Cord $\varnothing$
[mm]	[mm]
57	9
65	9
75	6



### Mat spacer (Distance $\leq 1.0$ m)

PT bar $\varnothing$	Dimensions			Number of ribs
	h	$L_1$	$L_2$	
[mm]	[mm]	[mm]	[mm]	[-]
57	11	170	165	4
65	11	220	165	5
75	11	220	165	5

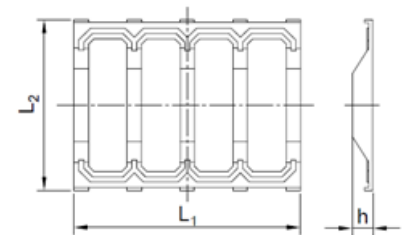

### Heat shrinking sleeve

Size	Diameter $\varnothing$ , before shrinking	Min. thickness after shrinking t
[mm]	[mm]	[mm]
50/20	50	1.0
70/25	70	1.0
90/30	90	1.0
120/40	120	1.0
170/80	170	1.0

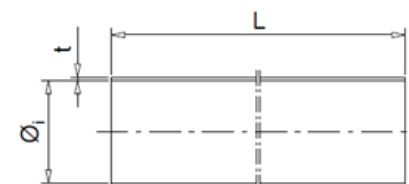

# Design guide SAS 835/1035

Accessories – (double) corrosion protection for rock and soil anchors

Injection end cap

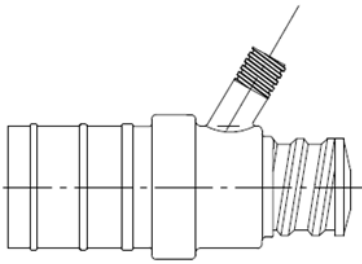

Alternative cap

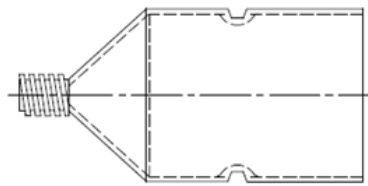

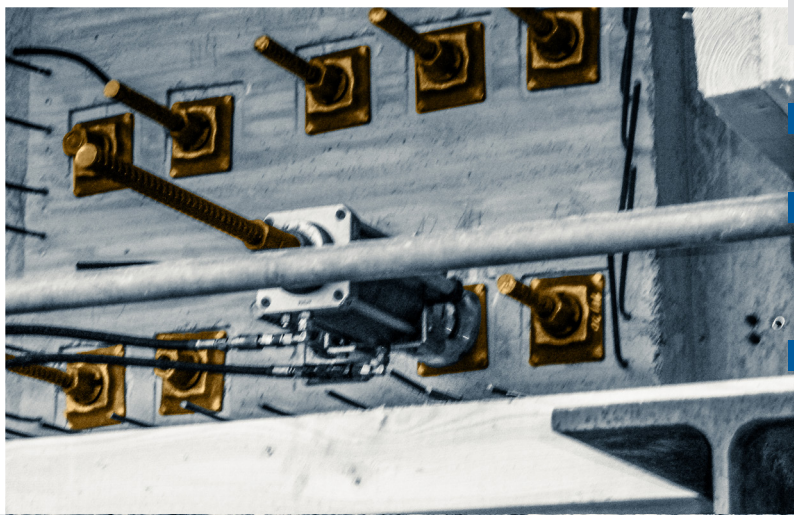
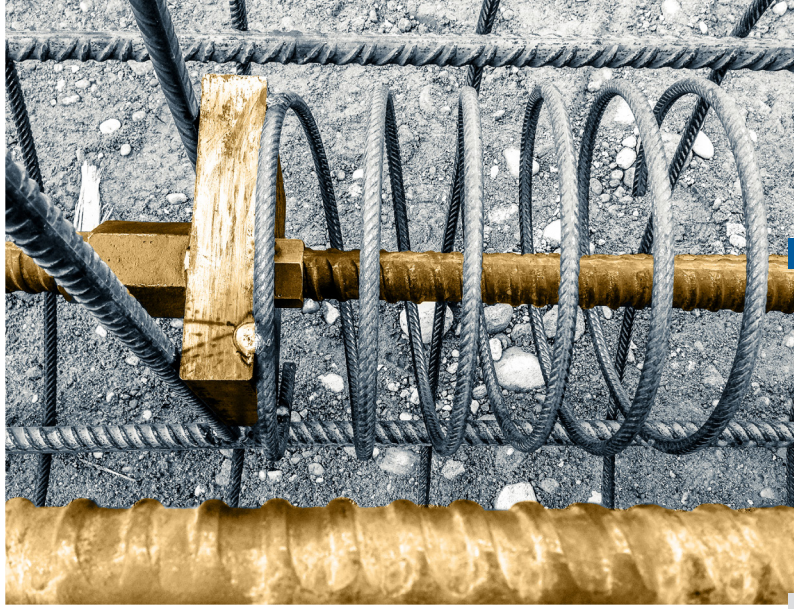



# SAS Gewindestäbe | SAS thread bar

Streckgrenze / Zugfestigkeit | yield stress / ultimate stress  
Anwendungsbereiche | areas of application

	Nenn- $\emptyset$ nom.- $\emptyset$	Strecklast yield load	Bruchlast ultimate load	Fläche cross section area	Gewicht weight	Dehnung elongation	
	[mm]	[kN]	[kN]	[mm <sup>2</sup> ]	[m/to]	[kg/m]	A <sub>gt</sub> [%]   A <sub>10</sub> [%]
<b>SAS 500 / 550 – grade 75</b>							
 Bewehrungstechnik   reinforcing systems	12	57	62	113	1123,6	0,89	6   10
	14	77	85	154	826,4	1,21	
	16	100	110	201	632,9	1,58	
	20	160	175	314	404,9	2,47	
	25	245	270	491	259,7	3,85	
	28	310	340	616	207,0	4,83	
 Geotechnik   geotechnical systems	32	405	440	804	158,5	6,31	
	36	510	560	1020	125,2	7,99	
	40	630	690	1260	101,3	9,87	
	43	726	799	1452	87,7	11,40	
	50	980	1080	1960	64,9	15,40	
SAS 555 / 700 – grade 80	57,5	1441	1818	2597	49,1	20,38	5   ---
SAS 555 / 700 – grade 80	63,5	1760	2215	3167	40,2	24,86	5   ---
SAS 500 / 550 – grade 75	75	2209	2430	4418	28,8	34,68	5   ---
<i>Alternativ SAS 550 erhältlich   alternative SAS 550 grade 75 available</i>							
<b>SAS 450 / 700 – grade 60</b>							
 Bergbau   mining	16	93	145	207	617,3	1,62	(A <sub>3</sub> ) 15
	25	220	345	491	259,7	3,85	(A <sub>3</sub> ) 20
<b>SAS 650 / 800 – grade 90</b>							
 Bergbau   mining	22	247	304	380	335,6	2,98	(A <sub>3</sub> ) 18
	25	319	393	491	259,7	3,85	
	28	400	493	616	207,0	4,83	
	30	460	565	707	180,2	5,55	
<b>SAS 670 / 800 – grade 97</b>							
 Geotechnik   geotechnical systems	18	170	204	254	500,0	2,00	5   10
	22	255	304	380	335,6	2,98	
	25	329	393	491	259,7	3,85	
 Ankertechnik   tunneling & mining	28	413	493	616	207,0	4,83	
	30	474	565	707	180,2	5,55	
	35	645	770	962	132,5	7,55	
 Hochfeste Bewehrung   high-strength reinforcement	43	973	1162	1452	87,7	11,40	
	50	1315	1570	1963	64,9	15,40	
	57,5	1740	2077	2597	49,1	20,38	
	63,5	2122	2534	3167	40,2	24,86	
75	2960	3535	4418	28,8	34,68	---	
<b>SAS 950 / 1050 – grade 150</b>							
 Spanntechnik   post-tensioning systems	18	230	255	241	510,2	1,96	5   7
	26,5	525	580	551	223,2	4,48	
	32	760	845	804	153,1	6,53	
 Geotechnik   geotechnical systems	36	960	1070	1020	120,9	8,27	
	40	1190	1320	1257	97,9	10,21	
	47	1650	1820	1735	70,9	14,10	
<b>SAS 835 / 1035 – grade 150</b>							
 Geotechnik   geotechnical systems	57	2155	2671	2581	47,7	20,95	---
	65	2780	3447	3331	36,9	27,10	---
	75	3690	4572	4418	27,9	35,90	---
<b>SAS 900 / 1100 FA – grade 160 FA</b>							
 Schalungstechnik   formwork ties	15	159	195	177	694,4	1,44	3   7
	20	283	345	314	390,6	2,56	
	26,5	495	606	551	223,2	4,48	
<b>SAS 900 / 1050 FC – grade 150 FC</b>							
 Schalungstechnik   formwork ties	15	159	186	177	694,4	1,44	3   7
	20	283	330	314	390,6	2,56	
SAS 950 / 1050 E - grade 150	26,5	525	580	551	223,2	4,48	5   7
<b>SAS 750 / 875 FS – kaltgerollt   cold rolled – grade 120 FS</b>							
 Schalungstechnik   formwork ties	12,5	90	120	132,5	961,5	1,04	2   5,5
	15	142	165	189	675,7	1,48	
	20	245	285	326	390,6	2,56	

Zubehör für alle Abmessungen und Anwendungen lieferbar | accessories for all dimensions and applications available